

cNODE® Transponders

Maxi and Midi - Medium Frequency, 4000 m



KONGSBERG

Introduction

cNODE® is a family of transponders for underwater acoustic positioning and data link and operates with both HiPAP®, HPR and cPAP® transceivers.

The Medium frequency (MF) cNODE® family consists of the following types, each with a separate product specification sheet:

- cNODE® Maxi and cNODE® Midi (Medium frequency, 4000 m)
- cNODE® Mini (Medium frequency, 4000 m)

cNODE® operates with either the HiPAP/HPR 400 channels and telemetry or with the new Cymbal® acoustic protocol.

The cNODE® design is very modular and covers a large range of applications with its variety of different transducers, internal and external sensors, housing materials and other add-on functions.

Both new configurations and software can easily be downloaded from the Transponder Test and Configuration unit (TTC30) without opening the transponder.

The floating collar and release design make the launch/recovery operation safe and easy. Spare parts for cNODE® are based on the main modules.

Common for all cNODE® transponders

- Operates together with HiPAP®, HPR and cPAP® transceivers.
- Compatible with both Cymbal® acoustic protocol for positioning and data link, and HiPAP®/HPR 400 channels and telemetry.
- SSBL positioning.
- LBL positioning.
- Range measurement between transponders (typical, 1 σ standard deviation):
 - Range accuracy: 0.02 m.
 - Repeatability: 0.01 m.
- Acoustic data link for command and data transfer.
- Both transponder and responder functions.
- Internal tilt sensor $\pm 90^\circ$. Accuracy $\pm 2^\circ$.
- Pressure relief valve and vent screw (safety devices).
- External connector for transponder configuration and software update via serial line (TTC30).
- Modular design such that the transducer, transponder electronics, battery pack and optional add-ons can be replaced individually.



Maxi 34-30V30H-R (Left)
Midi 34-180 (Right)

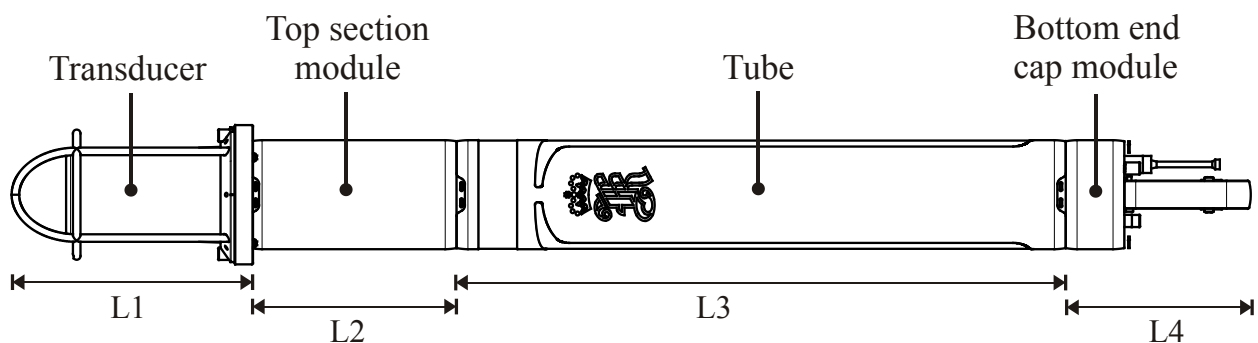

Total length = L1 + L2 + L3 + L4

(Cd302035)

cNODE® modular design

System overview cNODE Maxi/Midi

Transducers

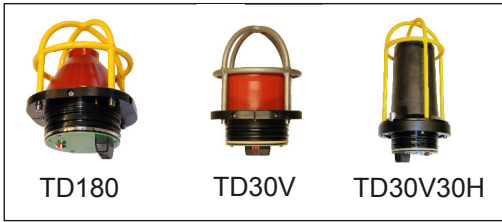

Remote transducers for Split transponders

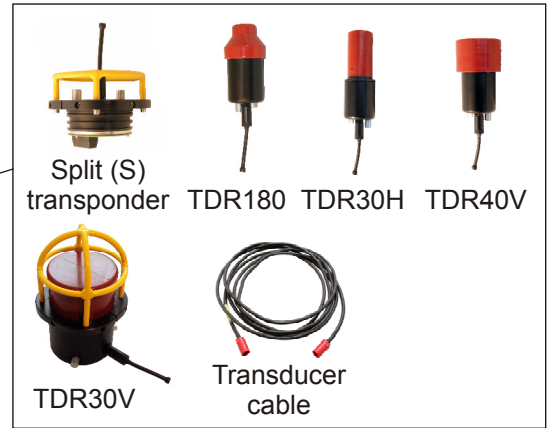

Top section modules

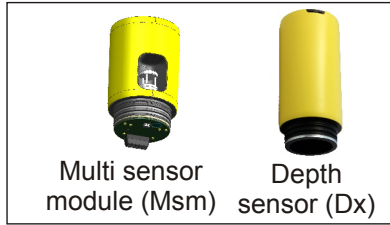

Chassis



Tubes



Bottom end cap modules

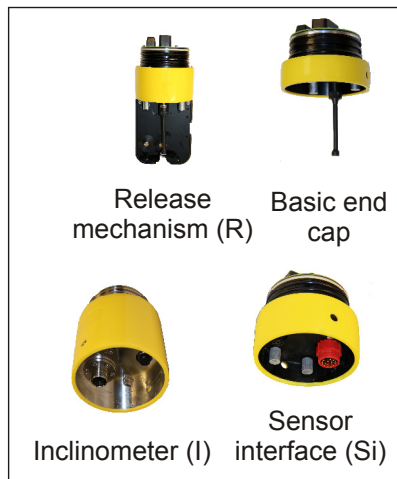

Batteries

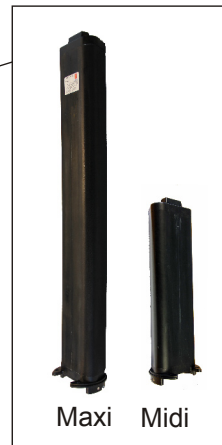

Auxillary equipment:

Floating collars



External sensors



Specifications for all Maxi and Midi transponders, Medium frequency

Frequency band: Medium frequency 21-31 kHz

Depth rating: 4000 m

Operating temperature: - 5 °C to + 55 °C

- Aluminium (Alu) transponders can only consist of Aluminium modules
- Stainless steel (St) transponders can only consist of Stainless steel modules

Transducers

TD180



TD30V

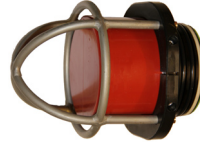

TD30V30H

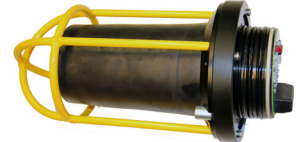

Beam width:	180°	30° vertical	30° vertical/30° horizontal
Receiver sensitivity:	100 dB	85 dB	85 dB
Source level - max:	190 dB	206 dB	206 dB/190 dB
Dimensions (L x dia):	169.5 x Ø166	169.5 x Ø166	316 x Ø184
Models (material):	Aluminium and Stainless steel	Aluminium and Stainless steel	Aluminium and Stainless steel
P/N:	319750 (Alu) and 320877 (St)	320662 (Alu) and 320077 (St)	313455 (Alu) and 359429 (St)

TDR - Remote transducers for Split transponders (S)

TDR 30H



TDR 180



TDR 40V



TDR 30V



Transducer cable (6m)



Beam width:	30° horizontal	180° horizontal	40° vertical	30° vertical	P/N: 345772
Receiver sensitivity:	100 dB	100 dB	90 dB	85 dB	Connectors:
Source level - max:	194 dB	190 dB	203 dB	206 dB	Subconn MCILF
Dimensions (L x dia):	262.4 x Ø77	209.8 x Ø88	218.6 x Ø100	279.5 x Ø166	and MCIL4M
Models (material):	Aluminium and Stainless steel	Aluminium and Stainless steel	Aluminium and Stainless steel	Aluminium and Stainless steel	
P/N:	345773 (Alu) and 375359 (St)	349742 (Alu) and 375361 (St)	349743 (Alu) and 375360 (St)	333445 (Alu) and 370447 (St)	

Top end caps

Split transponder (S) for remote transducer

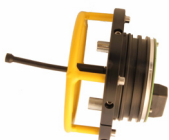

Dimensions (L x dia): 62 x Ø166
Model (material): Aluminium and Stainless steel
P/N: 320949 (Alu) and 322375 (St)

Top section modules

Depth sensor (Dx)



High accuracy depth sensor
Accuracy: 0.01% FS (FS = 400 bar)
Dimensions (L x dia): 272 x Ø144
Model (material): Aluminium
P/N: 350211

Multi Sensor Module (Msm)

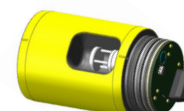

The module includes the following high accuracy sensors:

- Depth: 0,01% FS (FS = 400 bar)
- Inclinometer: 0.05°
- Sound velocity: ± 0.02 m/s

Dimensions (L x dia): 184 x Ø144
Model (material): Aluminium
P/N: 358791

Bottom end cap modules

Basic end cap



Dimensions (L x dia): 40 x Ø144
Model (material): Aluminium and Stainless steel
P/N: 330498 (Alu) and 330805 (St)

Release mechanism (R)



Safe working load: 500 kg
Dimensions (L x dia): 243 x Ø144
Model (material): Aluminium and Stainless steel
P/N: 325026 (Alu) and 356511 (St)

Sensor interface (Si)



Interface external sensors
 Subsea sensor data logger
Number of sensors: 3
Serial line: RS-232/-485/-422
Dimensions (L x dia): 72.8 x Ø144
Model (material): Aluminium and Stainless steel
P/N: 347652 (Alu) and 361410 (St)

Inclinometer (I)

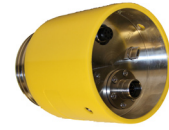

Internal X and Y inclinometer
Range: ± 60°
Accuracy: 0.25°
Dimensions (L x dia): 128 x Ø144
Model (material): Stainless steel
P/N: 320818

Tubes

Maxi



Coating: Polyurethane
Dimensions (L x dia): 805 x Ø144
Model (material): Aluminium and Stainless steel
P/N: 322312 (Alu) and 322316 (St)

Midi



Coating: Polyurethane
Dimensions (L x dia): 495 x Ø144
Model (material): Aluminium
P/N: 322340

Chassis with PCB

Maxi



P/N: 330762

Midi



P/N: 354043

Batteries

Maxi



Type: Lithium, non-rechargeable
Battery lifetime
 • **Quiescent:** 2.5 years
P/N: 319554

Midi



Type: Lithium, non-rechargeable
Battery lifetime
 • **Quiescent:** 1.25 years
P/N: 322374

Battery lifetime (example)

cNODE Maxi 34-180 Series, Cymbal:

Update rate/ TX power level	3 sec
Min	102 days
Low	84 days
High	48 days
Max	16 days

The battery lifetime varies according to transducer type, sensors, acoustic mode, transmitting power and activity. cNODE Midi battery lifetime is 50% of cNODE Maxi battery.

External sensors

External Inclinometer (II)

External X and Y inclinometer to be used together with Inclinometer (I)
Range: ± 60°
Accuracy: 0.25°
Dimensions (L x dia): 175 x Ø112
Model (material): Stainless steel
P/N: 322355



Third party external sensors (examples)

- Sound velocity
- Pressure sensor
- Temperature sensor
- Heading sensor
- Motion Reference Unit
- Doppler Velocity Log
- Environmental sensors
- Sea current sensor
- Altimeter
- Tide gauge

Floating collars

Maxi - Aluminium

Depth rating: 2000 and 4000 m
P/N: 320772 (2000 m)
319301 (4000 m)



Maxi - Stainless steel

Depth rating: 4000 m
P/N: 331151

Installation adapter kit for Basic end cap

Floating collar adapter for transponder models without Release Mechanism.
P/N: 369045 (Alu) and 372953 (St)

Accessories

TTC 30 - Transponder Test and Configuration unit*

Frequency band: Medium Frequency

The unit comes with:

- Test Transducer
- Serial Line Cable
- Mains Power Cable

P/N: 345775 TTC 30



* See separate TTC 30 Product Specification for more information.

cNODE Maxi 34 models

Examples of models

Aluminium

cNODE Maxi 34-180
cNODE Maxi 34-180-R
cNODE Maxi 34-180-Si
cNODE Maxi 34-30V
cNODE Maxi 34-30V-R
cNODE Maxi 34-30V-Si
cNODE Maxi 34-30V30H
cNODE Maxi 34-30V30H-R
cNODE Maxi 34-30V30H-Dx-R
cNODE Maxi 34-30V30H-Si
cNODE Maxi 34-S-R
cNODE Maxi 34-S-Si

Examples of models

Stainless Steel

cNODE Maxi 34-30V-I-St
cNODE Maxi 34-30V-II-St
cNODE Maxi 34-30V-St
cNODE Maxi 34-30V30H-St
cNODE Maxi 34-30V30H-R-St
cNODE Maxi 34-180-R-St
cNODE Maxi 34-180-Si-St
cNODE Maxi 34-30V-Si-St

cNODE Midi 34 models

Examples of models

Aluminium

cNODE Midi 34-180
cNODE Midi 34-180-Si
cNODE Midi 34-30V
cNODE Midi 34-30V-Si
cNODE Midi 34-30V30H
cNODE Midi 34-30V30H-Si
cNODE Midi 34-S-R
cNODE Midi 34-S-Si

Transponder model name description

cNODE Maxi/Midi 3 4 - TD type or - Top section - Bottom end - Material
Top end cap cap
3 = 30 kHz
4 = 4000 m
(Cd302051)

Transponder example

cNODE Maxi 34-180-R indicates that this transponder is operating in the 30 kHz band, is rated to 4000 m depths, with a 180° transducer beam width and a release unit. The standard transponder tube material is Aluminium.

Maxi outline drawings

Maxi 34-30V30H-R and Maxi 34-30V30H-R-St

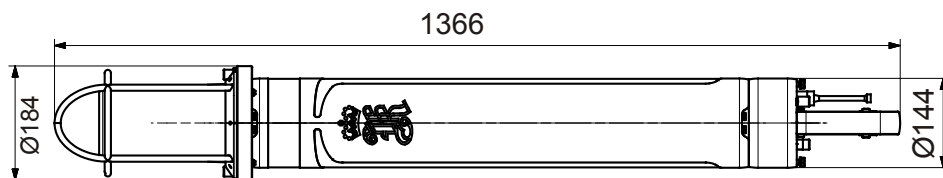

Weight in air: 30 kg (Alu) and 63 kg (St)

Weight in water: 13 kg (Alu) and 43 kg (St)

Maxi 34-30V and Maxi 34-30V-St

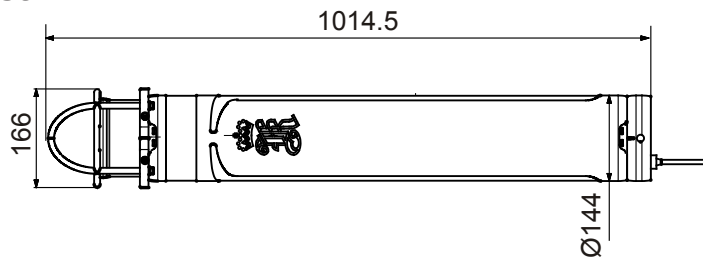

Weight in air: 28 kg (Alu) and 51 kg (St)

Weight in water: 13 kg (Alu) and 36 kg (St)

Floating collar outline drawing

Floating collar for Aluminium transponders, 4000 m

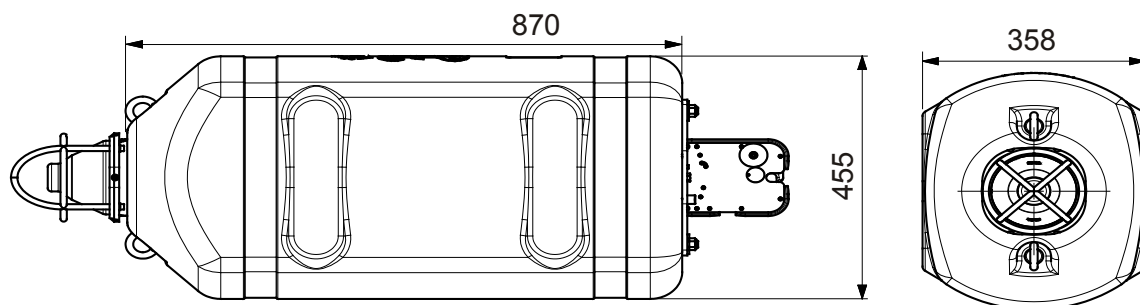

Weight in air: 70 kg

Nominal Buoyancy: 30 kg

Midi outline drawing

Midi 34-180

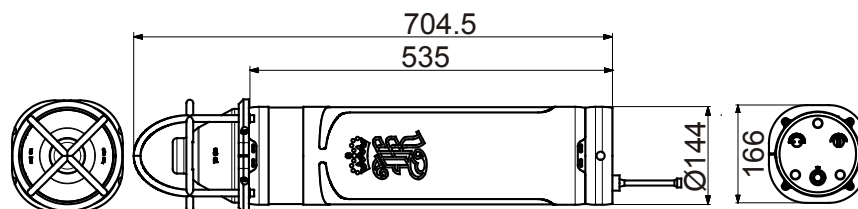

Weight in air: 16.5 kg (Alu)

Weight in water: 8.5 kg (Alu)

343341 / Rev. A / November 2012

Kongsberg Maritime AS

Strandpromenaden 50
P.O.Box 111
N-3191 Horten,
Norway

Telephone: +47 33 03 41 00
Telefax: +47 33 04 47 53
www.kongsberg.com
subsea@kongsberg.com



KONGSBERG